

























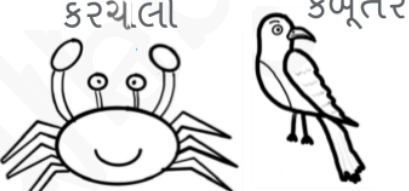

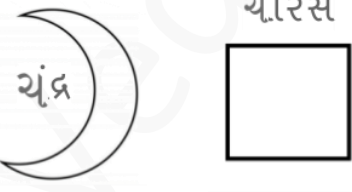
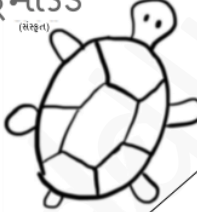







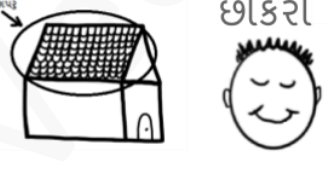



















<p>ક</p>  <p>ક</p>	<p>ખ</p>  <p>ખ</p>	<p>ગ</p>  <p>ગ</p>
<p>ઘ</p>  <p>ઘ</p>	<p>ઙ</p>  <p>ઙ</p>	<p>ચ</p>  <p>ચ</p>
<p>છ</p>  <p>છ</p>	<p>જ</p>  <p>જ</p>	<p>ઝ</p>  <p>ઝ</p>
<p>ઠ</p>  <p>ઠ</p>	<p>ટ</p>  <p>ટ</p>	<p>ડ</p>  <p>ડ</p>

<p>ગા Ga ગા</p> <p>ગાડી ગરુડ</p>  <p>ગધેડું ગાય માતા</p>  <p>ગા (ગળું - Guttural) ગા</p>	<p>ઘ Gha ઘ</p> <p>ઘોડો ઘડિયાળ</p>  <p>ઘેટું ઘર</p>  <p>ઘ (ગળું - Guttural) ઘ</p>	<p>ક Ka ક</p> <p>કાચબો કમળ</p>  <p>કચ્છલો કબૂતર</p>  <p>ક (ગળું - Guttural) ક</p>
<p>ચ Ch ચ</p> <p>ચકલી ચમચી</p>  <p>ચંદ્ર ચોરસ</p>  <p>ચ (તાળવું - Palatal) ચ</p>	<p>ઙ Ne ઙ</p> <p>ઙમોઙ (સિંહુના)</p>  <p>પાણુરજાષ્ટકં (સિંહુના)</p> <p>ઙ (ગળું - Guttural) ઙ</p>	<p>ઘ Gha ઘ</p> <p>ઘોડો ઘડિયાળ</p>  <p>ઘેટું ઘર</p>  <p>ઘ (ગળું - Guttural) ઘ</p>
<p>ઝ Za / Jha ઝ</p> <p>ઝાડ ઝબલું</p>  <p>ઝગમગવું ઝરણું</p>  <p>ઝ (તાળવું - Palatal) ઝ</p>	<p>જ Ja જ</p> <p>જલેબી જાનવર</p>  <p>જમરૂખ જહાજ</p>  <p>જ (તાળવું - Palatal) જ</p>	<p>છ Chh છ</p> <p>છત્રી છોકરી</p>  <p>છાપટું છોકરો</p>  <p>છ (તાળવું - Palatal) છ</p>

<p>ଋ</p>  <p>ଋ</p>	<p>ୠ</p>  <p>ୠ</p>	<p>ଌ</p>  <p>ଌ</p>
<p>ୡ</p>  <p>ୡ</p>	<p>ୢ</p>  <p>ୢ</p>	<p>ୣ</p>  <p>ୣ</p>
<p>୤</p>  <p>୤</p>	<p>୥</p>  <p>୥</p>	<p>୦</p>  <p>୦</p>

<p>ઠ Tha ઠ</p> <p>ઠળિયો ઠંડી</p> <p>ઠીકરું ઠીંગણું</p> <p>(જીભ પાછા ખેંચી- Retroflex) ઠ</p>	<p>ટ Ta ટ</p> <p>ટોપી ટપાલ</p> <p>ટમેટું ટચલી</p> <p>(જીભ પાછા ખેંચી- Retroflex) ટ</p>	<p>ઝ Na ઝ</p> <p>સઝીવનં (સંસ્કૃત - પાણકુરઙ્ગાષ્ટકમ)</p> <p>(તાળવું - Palatal) ઝ</p>
<p>ણ Na ણ</p> <p>રીંગણ હરણ</p> <p>બાણ ત્રણ (૩)</p> <p>(જીભ પાછા ખેંચી- Retroflex) ણ</p>	<p>ઢ Dha ઢ</p> <p>ઢોંગલી ઢેલ</p> <p>ઢોળાયેલું ઢગલો</p> <p>(જીભ પાછા ખેંચી- Retroflex) ઢ</p>	<p>ડ Da ડ</p> <p>ડાબી ડગલું</p> <p>ડબો ડમરું</p> <p>(જીભ પાછા ખેંચી- Retroflex) ડ</p>
<p>ઢ Da ઢ</p> <p>ઢફતર ઢર્પણ</p> <p>ઢડો ઢાઢા</p> <p>(ઢાંત - Dental) ઢ</p>	<p>થ Tha થ</p> <p>થેલી થડ</p> <p>થપ્પી થાક</p> <p>(ઢાંત - Dental) થ</p>	<p>ત Ta ત</p> <p>તારો તપેલું</p> <p>તલવાર તમરું</p> <p>(ઢાંત - Dental) ત</p>

<p>ઘ</p>  <p>ઘ</p>	<p>ઘ</p>  <p>ઘ</p>	<p>ન</p>  <p>ન</p>	<p>ન</p>  <p>ન</p>	<p>પ</p>  <p>પ</p>	<p>પ</p>  <p>પ</p>
<p>ઙ</p>  <p>ઙ</p>	<p>ઙ</p>  <p>ઙ</p>	<p>બ</p>  <p>બ</p>	<p>બ</p>  <p>બ</p>	<p>ભ</p>  <p>ભ</p>	<p>ભ</p>  <p>ભ</p>
<p>મ</p>  <p>મ</p>	<p>મ</p>  <p>મ</p>	<p>ય</p>  <p>ય</p>	<p>ય</p>  <p>ય</p>	<p>ર</p>  <p>ર</p>	<p>ર</p>  <p>ર</p>

પ Pa પ



પર્ણ
પેટ
પતંગ
પગ

પ (હોઠ - Labial) પ

ન Na ન



નળ
નાક
નાખ
નદી

ન (દાંત - Dental) ન

ધ Dha ધ

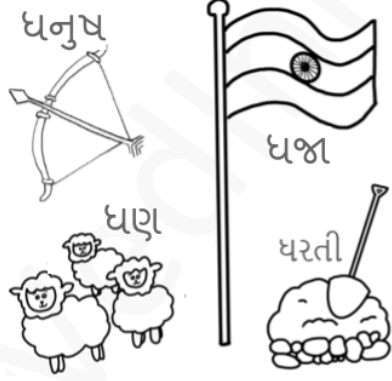

ધનુષ
ધજા
ધણ
ધરતી

ધ (દાંત - Dental) ધ

ભ Bha ભ



ભારત
ભમરો
ભમરડો
ભરતી

ભ (હોઠ - Labial) ભ

બ Ba બ

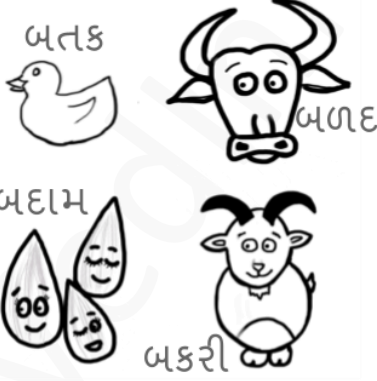

બતક
બદામ
બકરી
બળદ

બ (હોઠ - Labial) બ

ફ Pha ફ



ફટકડા
ફુગો
ફળો
ફૂલ

ફ (હોઠ - Labial) ફ

ર Ra ર



રસ્તો
રમકડાં
રાત
રીંછ

ર (જીભ પાછા ખેંચી - Retroflex) ર

ય Ya ય



યંત્ર
યાલ
યાત્રી
યજ્ઞ









ય (તાળવું - Palatal) ય







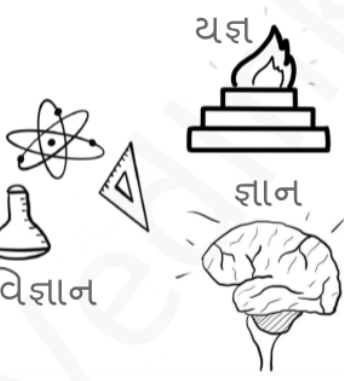











મ Ma મ



મેઘધનુષ
મગર
મગજ
મરચું

મ (હોઠ - Labial) મ

<p>શ શ</p> <p>Śa</p> <p>શીંગડા શનિ</p> <p>શિયાળ શંખ</p>  <p>શ શ</p> <p>(તાળવું - Palatal)</p>	<p>વ વ</p> <p>Va</p> <p>વર્તુળ વાઘ</p> <p>વાદળ વીટી</p>  <p>વ વ</p> <p>(હોઠ - Labial)</p>	<p>લ લ</p> <p>La</p> <p>લપસણી લોટ</p> <p>લસણ લખોટી</p>  <p>લ લ</p> <p>(દાંત - Dental)</p>
<p>હ હ</p> <p>Ha</p> <p>હાથી હરણ</p> <p>હોઠ હંસ</p>  <p>હ હ</p> <p>(હોઠ - Labial)</p>	<p>સ સ</p> <p>Sa</p> <p>સફરજન સસલું</p> <p>સંત સાપ</p>  <p>સ સ</p> <p>(દાંત - Dental)</p>	<p>ષ ષ</p> <p>Şa</p> <p>પુરુષ ષટકોણ</p> <p>ષટ્પદ્ય ઋષિ</p>  <p>ષ ષ</p> <p>(જીભ પાછા ખેંચી- Retroflex)</p>
<p>જ્ઞ જ્ઞ</p> <p>Jña/Gya</p> <p>(જ+ઞ)</p> <p>યજ્ઞ જ્ઞાન</p> <p>વિજ્ઞાન</p>  <p>જ્ઞ જ્ઞ</p> <p>(વિશેષ - Special)</p>	<p>ક્ષ ક્ષ</p> <p>Ksh/Xa</p> <p>(ક+ષ)</p> <p>ક્ષિતિજ ક્ષત્રિય</p> <p>ક્ષમા લક્ષ</p>  <p>ક્ષ ક્ષ</p> <p>(વિશેષ - Special)</p>	<p>ળ ળ</p> <p>La</p> <p>કેળું ફળો</p> <p>શિયાળ નળ</p>  <p>ળ ળ</p> <p>(વિશેષ - Special)</p>

<p>અ</p>  <p>અ</p>	<p>આ</p>  <p>આ</p>	<p>ઇ</p>  <p>ઇ</p>
<p>અ</p>  <p>અ</p>	<p>આ</p>  <p>આ</p>	<p>ઇ</p>  <p>ઇ</p>
<p>ઈ</p>  <p>ઈ</p>	<p>ઉ</p>  <p>ઉ</p>	<p>ઊ</p>  <p>ઊ</p>
<p>ઈ</p>  <p>ઈ</p>	<p>ઉ</p>  <p>ઉ</p>	<p>ઊ</p>  <p>ઊ</p>
<p>ઋ</p>  <p>ઋ</p>	<p>એ</p>  <p>એ</p>	<p>ઐ</p>  <p>ઐ</p>
<p>ઋ</p>  <p>ઋ</p>	<p>એ</p>  <p>એ</p>	<p>ઐ</p>  <p>ઐ</p>

ઇ I ઇ

ઇચળ ઇજા
ઇસ્તરી ઇમારત

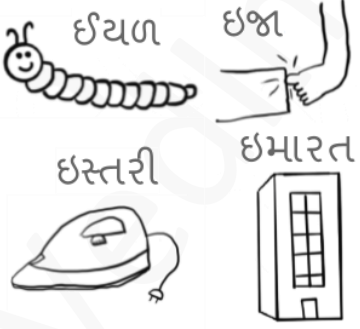

ઇ (સ્વર - vowel) ઇ

આ Aa/ Ā આ

આગગાડી આંખો
આદુ આગ



આ (સ્વર - vowel) આ

અ A અ

અગિયાર ૧૧ અજવાળું
અજગર અનાનસ



અ (સ્વર - vowel) અ

ઊ Oo/ Ū ઊ

ઊધઈ ઊંટ
ઊન ઊલિયું



ઊ (સ્વર - vowel) ઊ

ઉ U ઊ

ઉંદર ઉજ્વળ
ઉત્તરાયણ



ઉ (સ્વર - vowel) ઊ

ઈ Ee/ Ī ઈ

ઈંટો ઈશુ
ઈખ

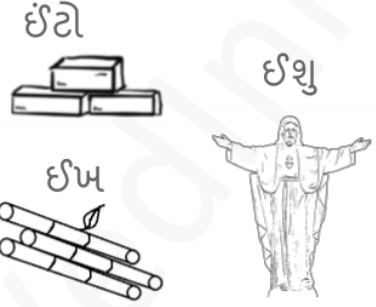

ઈ (સ્વર - vowel) ઈ

ઐ Ai ઐ

ઐશ્વર્યા ઐરાવત



ઐ (સ્વર - vowel) ઐ

એ E એ

એલચી એરણ
એડી



એ (સ્વર - vowel) એ

ઋ R̄/Rhu ઋ

ઋજુતા ઋષિ
ઋત્વિજ

ઋ = long R̄
(સ્વર - vowel)



ઋ (સ્વર - vowel) ઋ

ઓ	ઓ	ઔ	ઔ	એ	એ
ઓ	ઓ	ઔ	ઔ	એ	એ

ઓ	ઓ	અં	અં	અઃ	અઃ
ઓ	ઓ	અં	અં	અઃ	અઃ

વિલયન - ર

૨			
૨			
૨			

Conjugation

વિલયન - ઇ vs ઈ

ઈ		=		ઈ
ઈ		=		ઈ

Conjugation

વિલયન - ઉ vs ઊ

ઉ		=		ઉ
ઉ		=		ઉ

Conjugation

એ Ē એ



અમેરિકા



એતોમ

એ (સ્વર - vowel)
Special for English એ

ઔ Au ઔ

ઔષધ



ઔદ

૧૪



ઔદ

૧૪

ઔદ



ઔદ



ઔદ

ઔ (સ્વર - vowel) ઔ

ઓ O ઓ

ઓશીકું



ઓટવાનું



ઓજાર







ઓ (સ્વર - vowel) ઓ

અઃ Ah અઃ

નમઃ





દુઃખ



અઃ (સ્વર - vowel) અઃ

અં Am અં

અંજીર

અંજીર

અંગૂઠી



અં (સ્વર - vowel) અં

ઔ ૦ ઔ

ઔકટોપસ



ઔરેન્જ



ઔ (સ્વર - vowel)
Special for English ઔ

વિલયન - U vs Oo/Ū

ઉ બિંદુ પુરુષ પૃથ્વી ઉ

ઊ રૂપી સૂર્ય દૂધ ઊ

Ru = { ૨+ઉ=રુ = રૂ → []
૨+ઊ=રૂ = રૃ → [] }

Conjugation

વિલયન - I vs Ee/Ī

ઈ દૃષ્ટિ સ્મિત ઈ ઈ જમીન

ઈ નદી જીત જમીન ઈ

Conjugation

વિલયન -

Ra ૩ ત્રણ (૩ = ૧+૨) [tra]

પૂર્વ (વ=૨+વ) [va]

ચંદ્ર (ચ=૬+૨) [dra]

શ્રુતિ (શ્ર=૧+૨) [shra]

પ્રકાશ (પ્ર=૫+૨) [Pra]

Conjugation

विलयन - ६



Conjugation

०

०



०

०

१

१



१

१

२

२













२

२

		<p><u>વિલયન</u> - da</p> <p>ઠ + ડા = ઢા</p> <p>ઠ + ઠ = ઢ</p> <p>ઠ + ધ = ઢ</p> <p>ઠ + ન = ઢ</p> <p>ઠ + બ = ઢ</p> <p>ઠ + મ = ઢ</p> <p>ઠ + ય = ઢ</p> <p>ઠ + વ = ઢ</p> <p>Conjugation</p>
--	--	---

--	--	--

૨	૨	૨	૧	૧	૦	૦	૦
							
પ્રકૃતિ + પુરુષ			એક ઐકાર				
૨	બે	૨	૧	એક	૦	શૂન્ય	૦

<p>3 3</p> 	<p>8 8</p> 	<p>4 4</p> 
<p>3 3</p> <p>5 5</p> 	<p>8 8</p> <p>9 9</p> 	<p>4 4</p> <p>7 7</p> 
<p>5 5</p> <p>6 6</p> 	<p>9 9</p>	<p>7 7</p>

५ 5 ५

(पंचमहाभूत)

५ पांच ५

४ 4 ४

(सप्तऋषि)

४ चार ४

3 3 3

बिल्व पत्र

3 बे 3

८ 8 ८

(अष्टांग नमस्कार)

८ आठ ८

७ 7 ७

(सप्तऋषि)

७ सात ७

५ 6 ५

(वेदांग)

५ छ ५

८ 8 ८

८ 8 ८

९ 9 ९

(नवधा भक्ति)

९ नव ९